

## DM5406/DM7406 Hex Inverting Buffers with High Voltage Open-Collector Outputs

### General Description

This device contains six independent buffers each of which performs the logic INVERT function. The open-collector outputs require external pull-up resistors for proper logical operation.

### Pull-Up Resistor Equations

$$R_{MAX} = \frac{V_O (Min) - V_{OH}}{N_1 (I_{OH}) + N_2 (I_{IH})}$$

$$R_{MIN} = \frac{V_O (Max) - V_{OL}}{I_{OL} - N_3 (I_{IL})}$$

Where:  $N_1 (I_{OH})$  = total maximum output high current for all outputs tied to pull-up resistor

$N_2 (I_{IH})$  = total maximum input high current for all inputs tied to pull-up resistor

$N_3 (I_{IL})$  = total maximum input low current for all inputs tied to pull-up resistor

### Connection Diagram

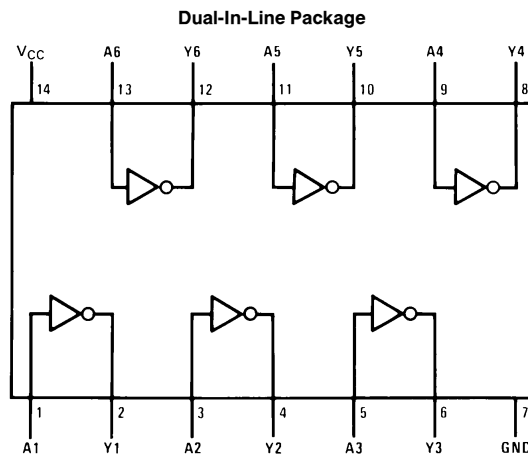

TL/F/6496-1

Order Number DM5406J, DM5406W, DM7406M or DM7406N  
See NS Package Number J14A, M14A, N14A or W14B

### Function Table

$$Y = \bar{A}$$

Input	Output
A	Y
L	H
H	L

H = High Logic Level

L = Low Logic Level

## Absolute Maximum Ratings (Note)

If Military/Aerospace specified devices are required, please contact the National Semiconductor Sales Office/Distributors for availability and specifications.

Supply Voltage	7V
Input Voltage	5.5V
Output Voltage	30V
Operating Free Air Temperature Range	
DM54	−55°C to +125°C
DM74	0°C to +70°C
Storage Temperature Range	−65°C to +150°C

Note: The "Absolute Maximum Ratings" are those values beyond which the safety of the device cannot be guaranteed. The device should not be operated at these limits. The parametric values defined in the "Electrical Characteristics" table are not guaranteed at the absolute maximum ratings. The "Recommended Operating Conditions" table will define the conditions for actual device operation.

## Recommended Operating Conditions

Symbol	Parameter	DM5406			DM7406			Units
		Min	Nom	Max	Min	Nom	Max	
V <sub>CC</sub>	Supply Voltage	4.5	5	5.5	4.75	5	5.25	V
V <sub>IH</sub>	High Level Input Voltage	2			2			V
V <sub>IL</sub>	Low Level Input Voltage			0.8			0.8	V
V <sub>OH</sub>	High Level Output Voltage			30			30	V
I <sub>OL</sub>	Low Level Output Current			30			40	mA
T <sub>A</sub>	Free Air Operating Temperature	−55		125	0		70	°C

## Electrical Characteristics over recommended operating free air temperature range (unless otherwise noted)

Symbol	Parameter	Conditions	Min	Typ (Note 1)	Max	Units
V <sub>I</sub>	Input Clamp Voltage	V <sub>CC</sub> = Min, I <sub>I</sub> = −12 mA			−1.5	V
I <sub>CEX</sub>	High Level Output Current	V <sub>CC</sub> = Min, V <sub>O</sub> = 30V V <sub>IL</sub> = Max			250	μA
V <sub>OL</sub>	Low Level Output Voltage	V <sub>CC</sub> = Min, I <sub>OL</sub> = Max V <sub>IH</sub> = Min			0.7	V
		I <sub>OL</sub> = 16 mA, V <sub>CC</sub> = Min			0.4	
I <sub>I</sub>	Input Current @ Max Input Voltage	V <sub>CC</sub> = Max, V <sub>I</sub> = 5.5V			1	mA
I <sub>IH</sub>	High Level Input Current	V <sub>CC</sub> = Max, V <sub>I</sub> = 2.4V			40	μA
I <sub>IL</sub>	Low Level Input Current	V <sub>CC</sub> = Max, V <sub>I</sub> = 0.4V			−1.6	mA
I <sub>CCH</sub>	Supply Current with Outputs High	V <sub>CC</sub> = Max		30	48	mA
I <sub>CCL</sub>	Supply Current with Outputs Low	V <sub>CC</sub> = Max		27	51	mA

## Switching Characteristics at V<sub>CC</sub> = 5V and T<sub>A</sub> = 25°C (See Section 1 for Test Waveforms and Output Load)

Symbol	Parameter	Conditions	Min	Max	Units
t <sub>PLH</sub>	Propagation Delay Time Low to High Level Output	C <sub>L</sub> = 15 pF R <sub>L</sub> = 110Ω		15	ns
t <sub>PHL</sub>	Propagation Delay Time High to Low Level Output			23	ns

Note 1: All typicals are at V<sub>CC</sub> = 5V, T<sub>A</sub> = 25°C.

**Physical Dimensions** inches (millimeters)

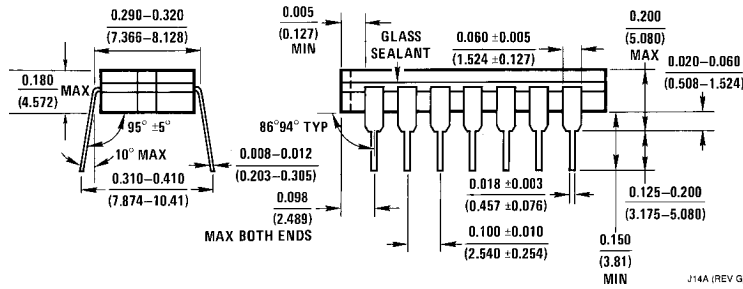
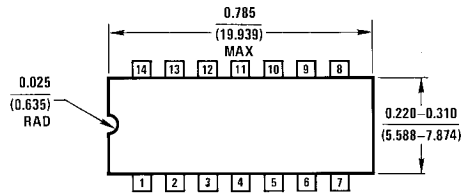

**14-Lead Ceramic Dual-In-Line Package (J)**  
**Order Number DM5406J**  
**NS Package Number J14A**

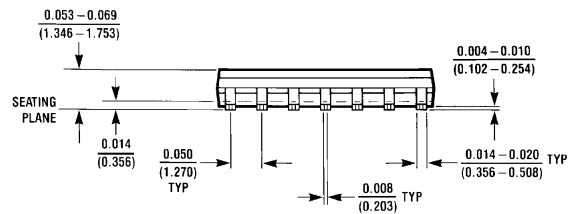
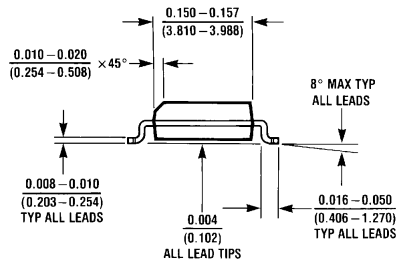
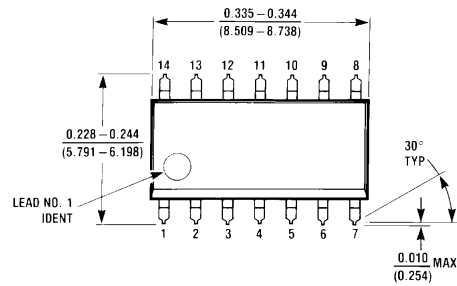

**14-Lead Small Outline Molded Package (M)**  
**Order Number DM7406M**  
**NS Package Number M14A**

**Physical Dimensions** inches (millimeters) (Continued)

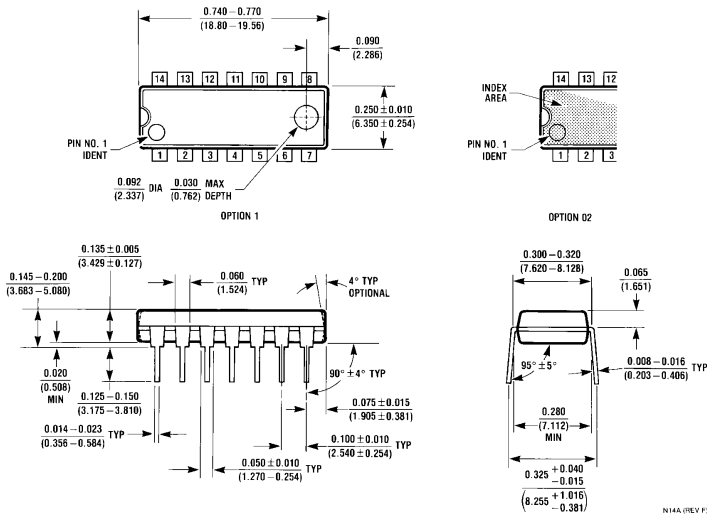

**14-Lead Molded Dual-In-Line Package (N)**  
**Order Number DM7406N**  
**NS Package Number N14A**

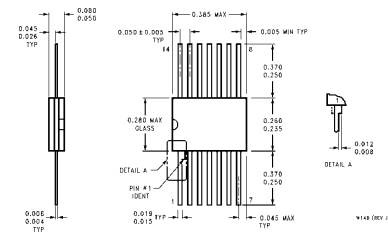

**14-Lead Ceramic Flat Package (W)**  
**Order Number DM5406W**  
**NS Package Number W14B**

**LIFE SUPPORT POLICY**

NATIONAL'S PRODUCTS ARE NOT AUTHORIZED FOR USE AS CRITICAL COMPONENTS IN LIFE SUPPORT DEVICES OR SYSTEMS WITHOUT THE EXPRESS WRITTEN APPROVAL OF THE PRESIDENT OF NATIONAL SEMICONDUCTOR CORPORATION. As used herein:

1. Life support devices or systems are devices or systems which, (a) are intended for surgical implant into the body, or (b) support or sustain life, and whose failure to perform, when properly used in accordance with instructions for use provided in the labeling, can be reasonably expected to result in a significant injury to the user.
2. A critical component is any component of a life support device or system whose failure to perform can be reasonably expected to cause the failure of the life support device or system, or to affect its safety or effectiveness.

 <p><b>National Semiconductor Corporation</b>          1111 West Bardin Road          Arlington, TX 76017          Tel: 1(800) 272-9959          Fax: 1(800) 737-7018</p>	<p><b>National Semiconductor Europe</b>          Fax: (+49) 0-180-530 85 86          Email: cnjwge@tevm2.nsc.com          Deutsch Tel: (+49) 0-180-530 85 85          English Tel: (+49) 0-180-532 78 32          Français Tel: (+49) 0-180-532 93 58          Italiano Tel: (+49) 0-180-534 16 80</p>	<p><b>National Semiconductor Hong Kong Ltd.</b>          19th Floor, Straight Block,          Ocean Centre, 5 Canton Rd.          Tsimshatsui, Kowloon          Hong Kong          Tel: (852) 2737-1600          Fax: (852) 2736-9960</p>	<p><b>National Semiconductor Japan Ltd.</b>          Tel: 81-043-299-2309          Fax: 81-043-299-2408</p>
--	--	---	---

National does not assume any responsibility for use of any circuitry described, no circuit patent licenses are implied and National reserves the right at any time without notice to change said circuitry and specifications.

This datasheet has been download from:

[www.datasheetcatalog.com](http://www.datasheetcatalog.com)

Datasheets for electronics components.